

NG 16

Aufnahmebohrung



moHy GmbH
 Röntgenstraße 4 · 63755 Alzenau
 Tel. +49 60 23 - 320 01 70
 Fax +49 60 23 - 320 01 66
 Email: moHy@moHy.info
 www.moHy.info



C1625

2,5-Wege

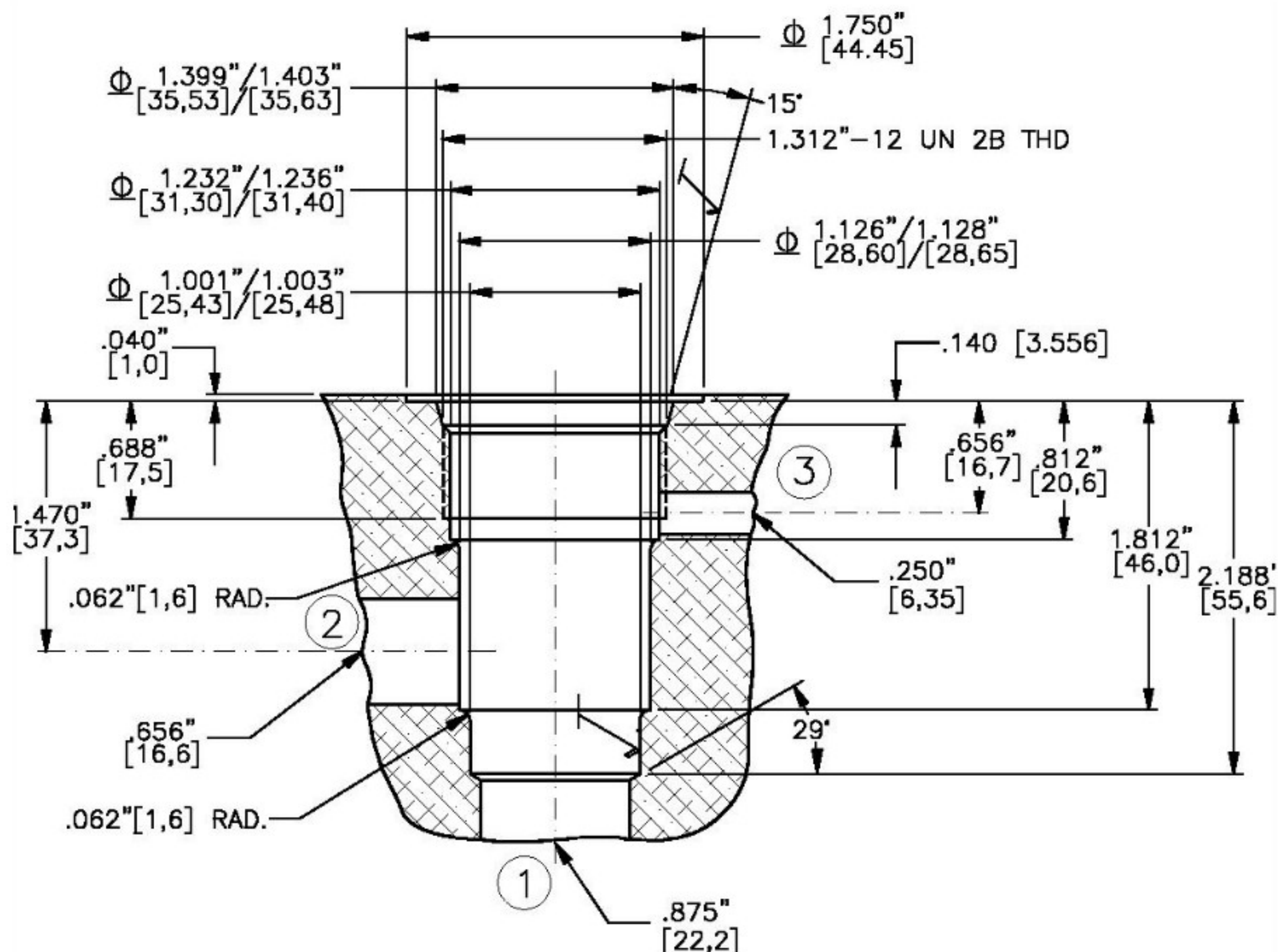

FINISH $\sqrt{}$ = 1,15m $\sqrt{}$ OR 45in $\sqrt{}$

Beachten: mm-Angaben in []

Cavity Roughing Tool

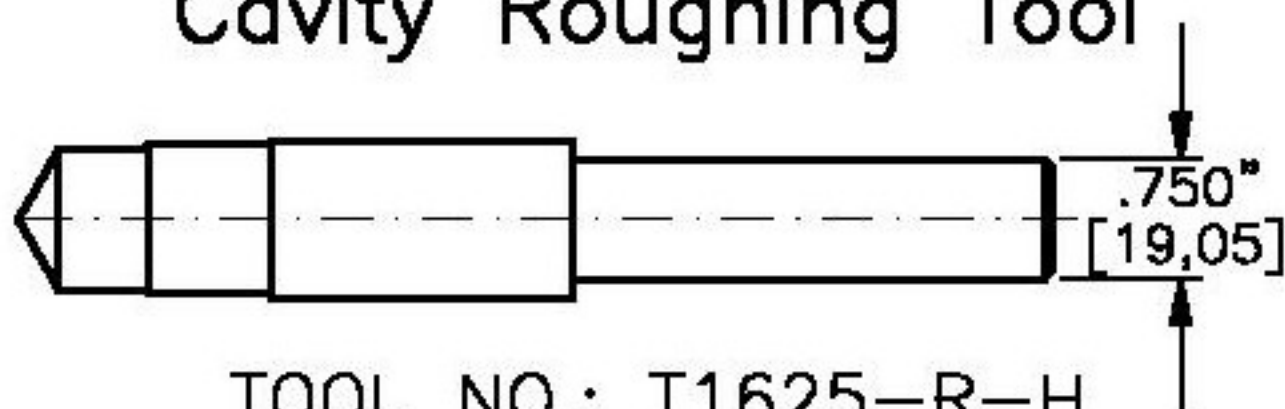

TOOL NO.: T1625-R-H
 MATERIAL: High Speed Steel

Cavity Finishing Tool

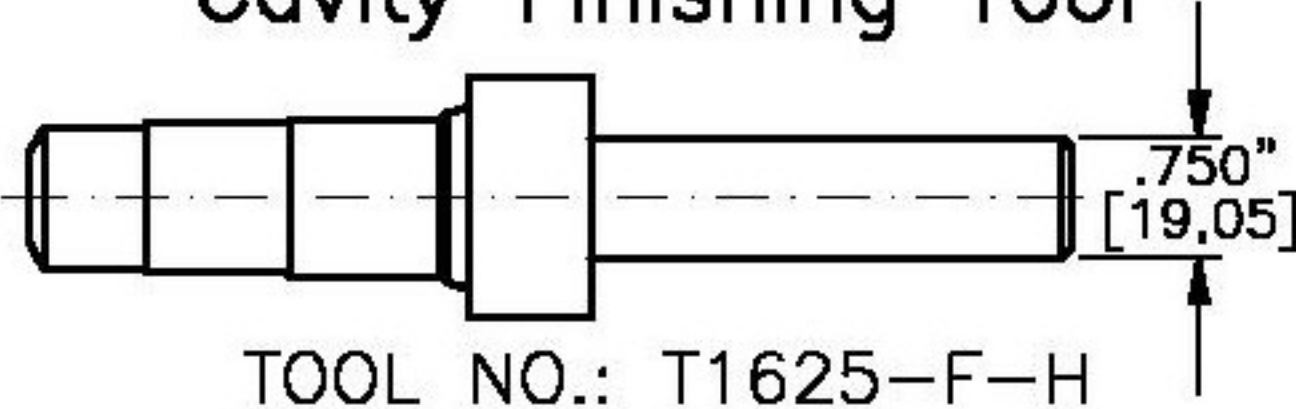

TOOL NO.: T1625-F-H
 MATERIAL: High Speed Steel
 TOOL NO.: T1625-F-C
 MATERIAL: Tungsten Carbide Tipped